



Laboratory water purification systems



WATER PURIFICATION SYSTEMS

Adrona water purification systems provide ultrapure (Grade 1), pure (Grade 2) and reverse osmosis (RO) water for laboratory needs. The quality of water meets the requirements of ISO 3696 standard and corresponding ASTM and CLSI standards.

Tap water systems	Water type	Page No.
Gradus	Ultrapure/pure	6
Q-Front N	Ultrapure/pure	9
Q-Front	Ultrapure/RO	10
Q-Front EDI	Ultrapure/pure	12
Q-Front EDI Pure	Pure	14
Integrity +	Ultrapure	16
E30	Ultrapure/pure	18
Crystal EX	Ultrapure/pure/RO ¹	20
Crystal EX Pure, Double Flow, RO	Pure/RO	23
Crystal Clinic	Pure	26
Crystal Sterifeed	Pure	28

Polishing systems	Water type	Page No.
Connect LT	Ultrapure	29
Onsite +	Ultrapure	30
Central laboratory systems		
Radix	Pure/RO	33
Accessories		34

1 depending on model, water purification systems can produce ultrapure and pure water or RO and pure water

ADRONA LABORATORY ULTRAPURE WATER SYSTEMS FEATURES

	Crystal EX	Q Front	Q FrontN	Integrity	Gradus	Connect	Onsite	Connect LT
Feed water	Tap water	Tap water	Tap water	Tap water	Tap water	Pre purified water	Pre Purified water	Pre Purified water
Prepared water	Gr2/Gr1	RO/Gr1	Gr2/Gr1	Gr1	Gr2/Gr1	Gr1	Gr1	Gr1
Display	Mono chrome	Colour	Colour	Colour	Colour touch screen	Colour	Colour	Colour touch screen
TOC monitor	No	Yes	Yes	Yes	Yes	Yes	Yes	Yes
Volume dispensing	No	Yes	Yes	Yes	Yes	Yes	Yes	Yes
Data Interface	No	RS232	RS232	RS232	Ethernet USB	RS232	RS232	Ethernet USB
Dispense reports	No	No	No	No	Yes	No	No	Yes
Data storage	No	No	No	No	Yes	No	No	Yes
GLP	No	No	No	No	Yes	No	No	Yes
Remote diagnostic	No	No	No	No	Yes	No	No	Yes

OVERVIEW

Adrona provides laboratory water solutions to any application – starting from Primary Grade Water (Grade 3) for simple washing and autoclave feed to Purified Water (Grade 2) for general laboratory use or Ultrapure Water (Grade 1) for highly sensitive applications.

The systems are manufactured based on more than two decades of experience in laboratory water purification, using verified configurations of systems and high grade components and materials.

The systems are installable by user and all cartridges and filters are user-replaceable. The initial set of consumables is delivered with each of our water system.

Adrona water purification systems can be installed either on a laboratory bench or on a wall¹. Wallmount installation provides savings of valuable laboratory space.

Requirements of GLP are met by the new Gradus and Connect LT systems.

Purified water quality of all our water purification systems can be validated by an external conductometer with flow cell which can be ordered from Adrona or bought locally.

Conformity of the systems to their specifications is provided in case the systems are properly installed and maintained.

TOTAL ORGANIC CARBON (TOC) MONITOR

Organic contaminants may not have effect on conductivity of water, so conductivity sensors cannot be used for TOC monitoring. Therefore, a special TOC monitoring module is needed to measure TOC level. Several models of Adrona water purification systems have the TOC monitor feature. TOC values are shown on display.

COLOUR GRAPHIC LCD DISPLAY

The 16-bit colour display provides clear readout of water quality, system component status, performance of the polishing module. System component status is reflected on the display in an intuitive colour pattern (Green/Yellow/Red).



VOLUMETRIC DISPENSE

Adrona water purification systems² feature a volumetric dispenser, which enables the user to set accurate dispensing volume for each dispense cycle. The dispense volume can be set either from the keyboard or by using “teaching” mode. In “teaching” mode user uses “Dispense On/OFF” button to do the first dispense cycle manually. Afterwards, the system will dispense exactly the same volume each time the user presses the dispense button again.

DISPLAYS

Provide clear water quality readout and information about the system status including current resistivity and remaining pre-filter service life.

LARGE TOUCHSCREEN

Simplified and detailed information in multiple languages. Alarms and alerts are visible on the main screen with a complete information on actions required. Monitoring the operation system.

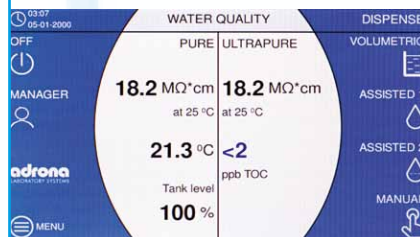

MONOCHROME HIGH RESOLUTION LCD DISPLAY



WATER QUALITY AND VALIDATION

Embedded recirculation loop ensures stable premium water quality and enables practical elimination of Total Organic Carbon (TOC).

Performance of deionization and polishing modules is constantly monitored. Monitoring algorithm enables cutting running costs, as replacement of the modules is requested only when service life is close to the end.

Stability of water quality is achieved by double Ion Exchange cartridge system 2. (Adrona systems incorporate 2 Ion Exchange cartridges (deionization and polishing) therefore excellent water quality is guaranteed even if one of them is waiting for replacement at the moment.

System flowchart shows all component status and water quality parameters at a glance. Image can vary depending on model and its configuration.

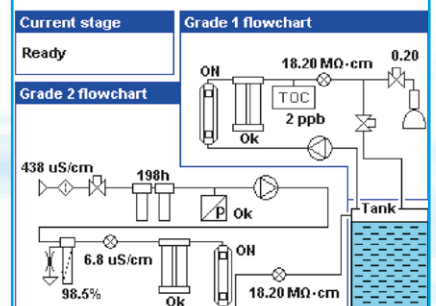

1 If not specified otherwise
2 Depends on model and configuration

ELECTRODEIONIZATION MODULE

For laboratories with high water consumption Adrona offers Q-Front or RADIX systems with an integrated EDI module. It allows to significantly reduce the running costs of water purification system due to EDI module which does not require replacement.

SAFETY

Adrona water purification systems feature all necessary safety functions. They are tested by an independent and accredited company for compliance with the CE directives related to safety and electromagnetic compatibility.

WARRANTY AND AFTER-SALES SUPPORT

Adrona provides 2 year warranty and continuous support. High customer satisfaction is our top priority in every aspect of business. Adrona's support has been greatly appreciated by dealers worldwide for its reliability and willingness to help. Continuously having all spare parts in stock enables us to guarantee short reaction times and quickly resolve any technical issues. Our support team is always ready to assist and in urgent cases dispatch the necessary components. Required repairs or technical maintenance is carried out

by appropriately trained local personal or Adrona's service engineers. In addition to spare parts, we ensure the availability of all consumables for the lifetime of every water purification system installed.

CERTIFICATION

ADRONA management system and manufacturing site operates in accordance with ISO 9001:2015. We are certified for manufacture, sale, and service of laboratory equipment.

CONFIGURATIONS ACCORDING TO APPLICATIONS

Each Adrona model is available in various configurations according to the customer needs

Water for laboratory needs		RO	Grade 2		Grade 1		
Applications		RO	Pure	EDI	Trace	HPLC	Bio
General laboratory applications	Glassware rinsing	•	•	•	•	•	•
	Laboratory washers	•	•	•	•	•	•
	Autoclaves	•	•	•	•	•	•
	Electrochemistry		•	•	•	•	•
	Wet chemistry		•	•	•	•	•
	Spectrophotometry		•	•	•	•	•
	Buffer and media preparation		•	•	•	•	•
	Reagent preparation		•	•	•	•	•
Inorganic analysis methods	Flame atomic absorption spectrophotometry		•	•	•	•	•
	Graphite automizer atomic absorption spectrophotometry				•	•	•
	Plasma mass-spectrometry (ICP-MS)				•	•	•
	Plasma spectrophotometry (ICP-OES)				•	•	•
	Ion chromatography				•	•	•
Organic analysis methods	Liquid chromatography (HPLC/ UHPLC)					•	•
	Gas chromatography					•	•
	Total organic carbon measurements					•	•
Molecular Biology	Flow cytometry						•
	Cell and tissue culture						•
	Molecular biology						•

GRADUS

Fully integrated pure and ultrapure intelligent water system. Superior quality of ultrapure and pure water is achieved directly from a tap water source.

Available in 2 configurations – deionization or EDI.



PRE-CLEAN PACK

High efficiency removal of colloids, particles, free chlorine and minerals for improved system performance.

EDI MODULE OR DI PACK

Removes remaining ions for consistently superior quality pure water. EDI system requires no maintenance, ensuring low and predictable costs.

ADVANCED REVERSE OSMOSIS (RO)

Removes 97-99% contaminants including ions, particles, bacteria and organic molecules, reduces feed water consumption for 60%.

PRIOR TO WATER PRODUCTION,

automatic rinsing of the RO membrane and the EDI module ensures that only the highest quality pure water enters the tank.

Attached G1 ultrapure water dispenser — delivers consistently ion free and low TOC ultrapure water.

Attached G2 pure water dispenser – delivers guaranteed quality Grade II pure water.

Within the tank, pure water quality is preserved by two built in features:

- Vent filter - provides protection against airborne contaminants
- Automatic Sanitization Module – with an integrated UVC regularly irradiates stored water and tank walls, preventing bacterial growth and biofilm formation.

Automatic recirculation of stored water through bactericidal UV lamp preserves water quality in the tank and ensures that high quality Grade II water is always on hand ready to use.

Ultra Pack Polishing Cartridge – removes ions and organic contaminants down to trace level.

Oxidation UV lamp – emitting 185 nm, photo-oxidises organic contaminants.

WATER QUALITY SPECIFICATIONS PROVIDED BY GRADUS

	LT	Bio	LT EDI	Bio EDI
Grade I water resistivity at 25 °C	18.2 MΩ x cm	18.2 MΩ x cm	18.2 MΩ x cm	18.2 MΩ x cm
Grade I water conductivity at 25 °C	0.055 μS/ cm	0.055 μS/ cm	0.055 μS/ cm	0.055 μS/ cm
Grade II water conductivity at 25 °C	0.1 - 0.2 μS/ cm	0.1 - 0.2 μS/ cm	0.1 - 0.2 μS/ cm	0.1 - 0.2 μS/ cm
Total Organic Carbon (TOC) level	< 2 ppb	< 2 ppb	< 2 ppb	< 2 ppb
RNase	-	< 0.01 ng/mL	-	< 0.01 ng/mL
DNase	-	< 4 pg/μL	-	< 4 pg/μL
Bacteria	< 0.01 CFI/mL	< 0.01 CFI/mL	< 0.01 CFI/mL	< 0.01 CFI/mL
Endotoxins	< 0.15 EU/mL	< 0.001 EU/mL	< 0.15 EU/mL	< 0.001 EU/mL
Particles >0.22 μm	< 1/mL	< 0.05/mL	< 1/mL	< 0.05/mL
Nominal flow, EDI water (to storage tank)	5/10 L/h	5/10 L/h	5/10 L/h	5/10 L/h
Dispense rate, ultrapure water	up to 2.0 L/min	up to 2.0 L/min	up to 2.0 L/min	up to 2.0 L/min
Drop-by-drop	up to 20 L	up to 20 L	up to 20 L	up to 20 L

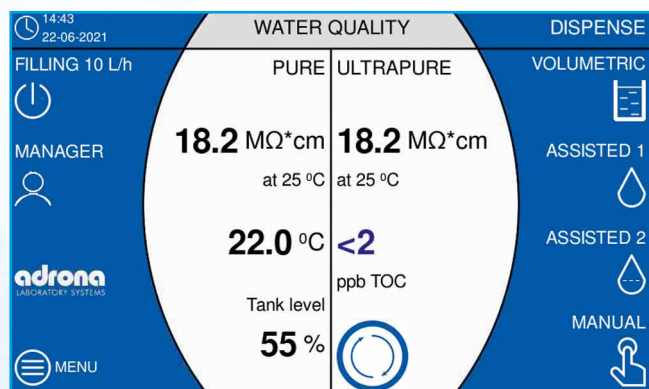

COMPACT

- Total dimensions: 330 mm wide, 630 mm high
- Integral to your bench work

LARGE TOUCHSCREEN

- Simplified and detailed information in multiple languages
- Alerts and alarms are visible on the main screen with complete information on actions required
- Monitoring the operation of the system.

EASY TO USE

- Water delivered up to 2 liters a minute keeps interruptions to a minimum
- Volumetric dispensing allows fast reissue of volumes
- Volumetric control is available from 20 ml to 20 liters

CONVENIENT

- Installation process gives quick access to laboratory water
- Easy menu navigation in multiple languages
- Easy access to change consumables

COST EFFECTIVE

- All consumables included
- Large volume DI cartridge
- Space saving design means a more efficient laboratory and team

FLOW DIAGRAM

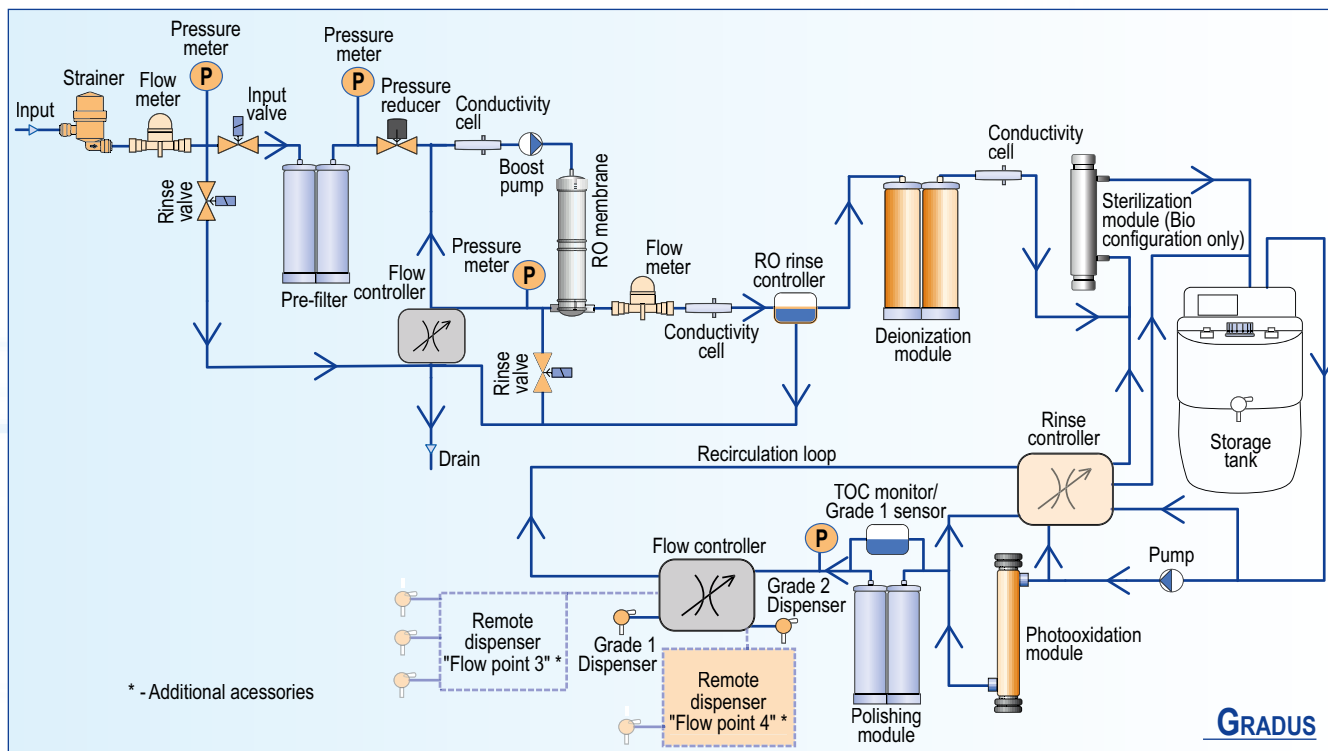

FLOW DIAGRAM

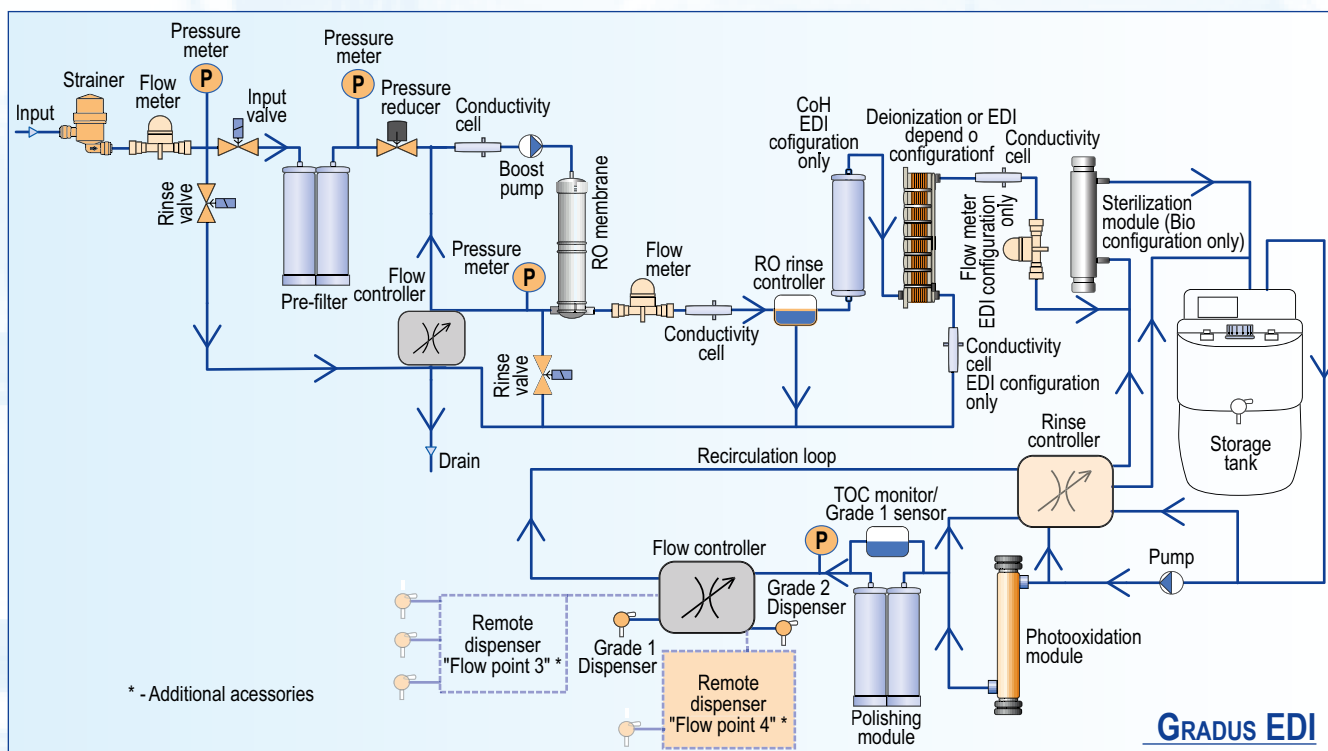



Q-FRONT N

Q-Front N is a new addition to Adrona's product range and is intended as a successor to our popular and highly appreciated B30 system. It is an excellent choice for your laboratory, providing both Grade I and Grade II water directly from tap water.

With Q-Front N series we have introduced new tool-free quick connectors for effortless cartridge replacement and a redesigned flexible dispenser, ensuring ergonomic and convenient daily operation.

Like the other Adrona water purification systems, Q-Front N is available in Trace, HPLC, Bio and Bio UF configurations to meet the specific needs of every laboratory and application.

FLOW DIAGRAM

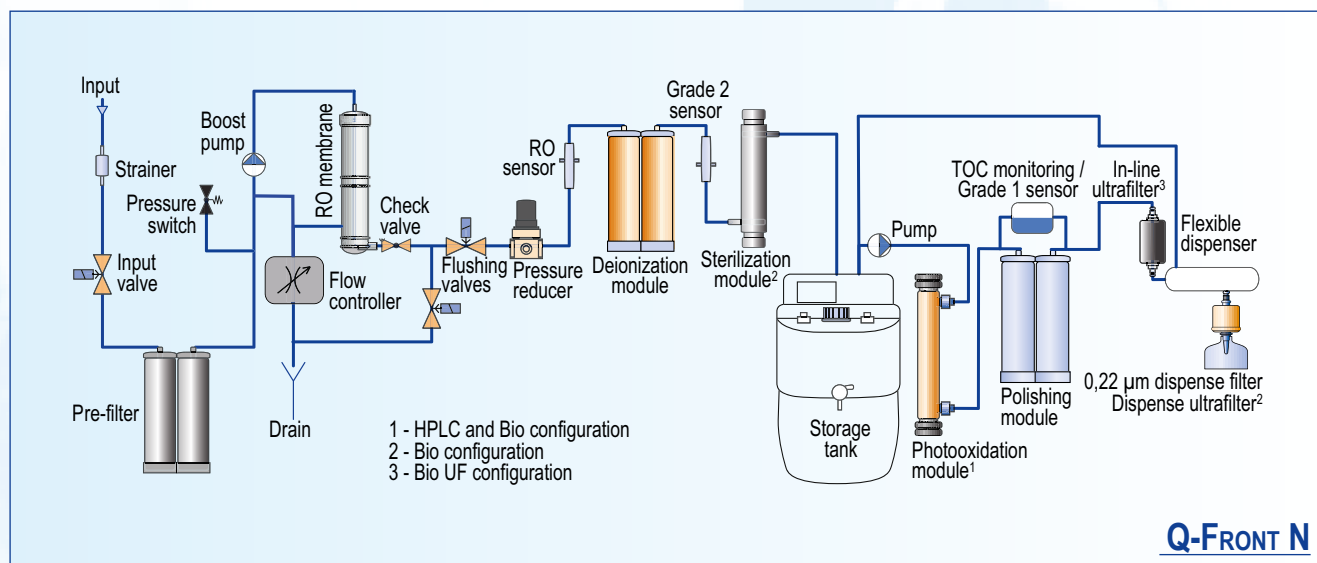

WATER QUALITY SPECIFICATIONS BY Q-FRONT N

	Trace	HPLC	Bio	Bio UF
Grade 1 water resistivity at 25 °C	18.2 MΩ x cm	18.2 MΩ x cm	18.2 MΩ x cm	18.2 MΩ x cm
Grade 1 water conductivity at 25 °C	0.055 µS/cm	0.055 µS/cm	0.055 µS/cm	0.055 µS/cm
Grade 2 water resistivity at 25 °C	>10 MΩ x cm	>10 MΩ x cm	>10 MΩ x cm	>10 MΩ x cm
Grade 2 water conductivity at 25 °C	<0.1 µS/cm	<0.1 µS/cm	<0.1 µS/cm	<0.1 µS/cm
Total Organic Carbon (TOC) level	<10 ppb	<2 ppb	<2 ppb	<2 ppb
RNase	-	-	<0.01 ng/mL	-
DNase	-	-	<4 pg/µL	-
Bacteria	<0.01 CFU/mL	<0.01 CFU/mL	<0.01 CFU/mL	<0.01 CFU/mL
Endotoxins	<0.15 EU /mL	<0.15 EU /mL	<0.001 EU /mL	-
Particles >0.22 µm	<1/ per mL	<1/ per mL	-	-
Nominal flow, pure water (to storage tank)	10 L/h	10 L/h	10 L/h	10 L/h
Dispense rate, ultrapure water	Up to 2 L/min	Up to 2 L/min	Up to 2 L/min	Up to 2 L/min

Q-FRONT

Adrona's products Q-Front 5/10 are ultrapure water systems where water deionization and polishing are provided by one ion exchange cartridge. It simplifies servicing of the system and decreases the unit cost.

RO permeate water is stored in the tank and delivered to polishing loop by the pump.

Grade 1 water can be dispensed by attached dispenser, including volumetric dispensing. All-well known Grade 1 systems configurations - Trace, HPLC and Bio are available.



DESCRIPTION

	Q-Front Trace	Q-Front HPLC	Q-Front Bio	Q-Front Bio UF
Q-Front water type	<ul style="list-style-type: none"> ultrapure water (Grade 1) RO water (Grade 3) 	<ul style="list-style-type: none"> ultrapure water (Grade 1) RO water (Grade 3) 	<ul style="list-style-type: none"> ultrapure water (Grade 1) RO water (Grade 3) 	
Application	<ul style="list-style-type: none"> atomic absorption spectrometry plasma optical emission spectrometry other inorganic trace analysis 	<ul style="list-style-type: none"> chromatography mass spectrometry microbiology molecular biology 	<ul style="list-style-type: none"> highly sensitive molecular biology cell culture other methods sensitive to RNase and endotoxins biology applications 	
Display	colour graphic LCD display			
Water quality sensor	•	•	•	•
TOC Monitor	-	•	•	•
Measurement validation port	•	•	•	•
Volumetric dispense	•	•	•	•
Dispenser	flexible dispenser attached			
Connection to Flow point*	•	•	•	•
In-line ultrafilter	-	-	-	•
Storage tank	tank "Pro" 30 L included, other tanks optional			
Installation	installable on a laboratory bench			

* Dispenser-ready configuration required



SPECIFICATIONS

	Q-Front system configuration			
	Trace	HPLC	Bio	Bio UF
Grade 1 water resistivity at 25 °C	18.2 MΩ x cm	18.2 MΩ x cm	18.2 MΩ x cm	
Grade 1 water conductivity at 25 °C	0.055 μS/cm	0.055 μS/cm	0.055 μS/cm	
Total Organic Carbon (TOC) level	<10 ppb	<2 ppb	<2 ppb	
RNase	-	-	<0.01 ng/mL	
DNase	-	-	<4 pg/μL	
Bacteria	<0.01 CFU/mL	<0.01 CFU/mL	<0.01 CFU/mL	
Endotoxins	<0.15 EU /mL	<0.15 EU /mL	<0.001 EU /mL	
Particles >0.22 μm	<1/mL	<1/mL	<1/mL	
Deionization module life*	1 m ³ *	1 m ³ *	1 m ³ *	
Feed water pressure	0.4 - 6 bar	0.4 - 6 bar	0.4 - 6 bar	
Data interface	RS 232	RS 232	RS 232	
Dimensions (WxDxH), cm	35x39x54	35x39x54	35x39x54	
System weight, kg	25 (27)	26 (28)	27 (29)	
Operation weight, kg	28 (31)	29 (32)	30 (33)	

FLOW DIAGRAM

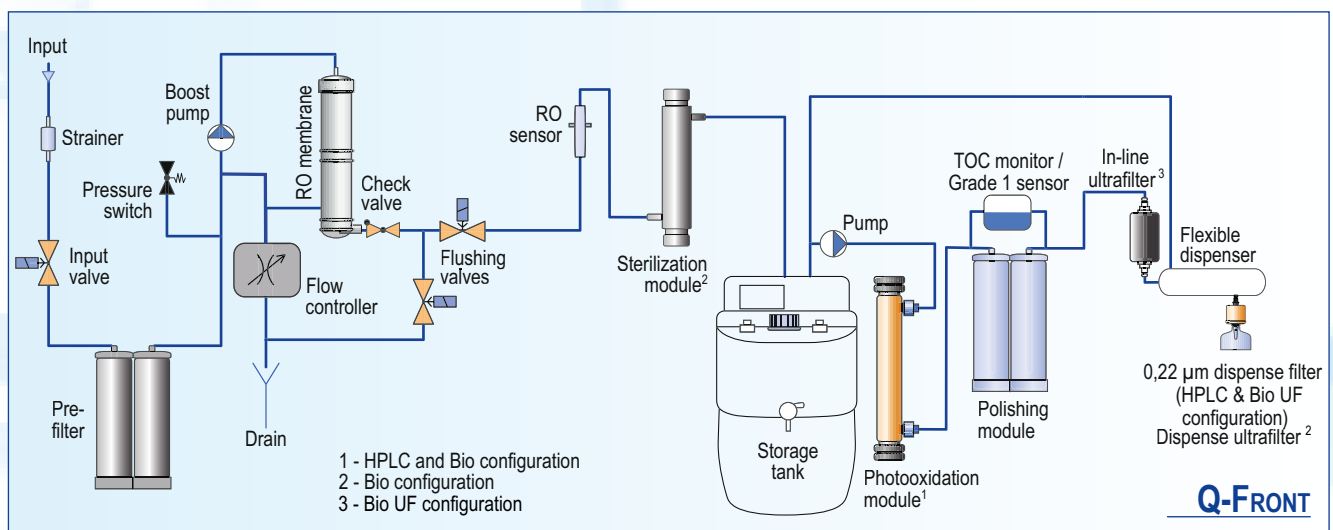

Q-FRONT EDI

Adrona's product Q-Front EDI is a tap water system for general laboratory applications and inorganic analytical methods. Q-Front EDI systems are intended for use in laboratories with high daily pure and ultrapure water consumption. Q-Front EDI systems include the new flexible dispenser (excepting Pure configuration).



DESCRIPTION

	Q-Front EDI Trace	Q-Front EDI HPLC	Q-Front EDI Bio	Q-Front EDI Bio UF
Q-Front EDI water type	<ul style="list-style-type: none"> • ultrapure water (Grade 1) • pure water (Grade 2) 	<ul style="list-style-type: none"> • ultrapure water (Grade 1) • pure water (Grade 2) 	<ul style="list-style-type: none"> • ultrapure water (Grade 1) • pure water (Grade 2) 	
Application	<ul style="list-style-type: none"> • atomic absorption spectrometry • plasma optical emission spectrometry • other inorganic trace analysis 	<ul style="list-style-type: none"> • chromatography • mass spectrometry • microbiology • molecular biology 	<ul style="list-style-type: none"> • highly sensitive molecular biology • cell culture • other methods sensitive to RNase and endotoxins • biology applications 	
Display	colour graphic LCD display			
Water quality sensor	•	•	•	•
TOC Monitor	-	•	•	•
Measurement validation port	•	•	•	•
Volumetric dispense	•	•	•	•
Dispenser	flexible dipenser attached			
Connection to Flow point*	•	•	•	•
In-line ultrafilter	-	-	-	•
Storage tank	tank "Pro" 30 L included, other tanks optional			
Installation	installable on a laboratory bench			

* Dispenser-ready configuration required



SPECIFICATIONS

	Q-Front EDI system configuration			
	Trace	HPLC	Bio	Bio UF
Grade 1 water resistivity at 25 °C	18.2 MΩ x cm	18.2 MΩ x cm	18.2 MΩ x cm	
Grade 1 water conductivity at 25 °C	0.055 μS/cm	0.055 μS/cm	0.055 μS/cm	
Grade 2 water conductivity at 25 °C	0.1 μS/cm	0.1 μS/cm	0.1 μS/cm	
Total Organic Carbon (TOC) level	<10 ppb	<2 ppb	<2 ppb	
RNase	-	-	<0.01 ng/mL	
DNase	-	-	<4 pg/μL	
Bacteria	<0.01 CFU/mL	<0.01 CFU/mL	<0.01 CFU/mL	
Endotoxins	<0.15 EU /mL	<0.15 EU /mL	<0.001 EU /mL	
Particles >0.22 μm	<1/mL	<1/mL	<1/mL	
Deionization module life*	1 m ³ *	1 m ³ *	1 m ³ *	
Feed water pressure	0.4 - 6 bar	0.4 - 6 bar	0.4 - 6 bar	
Data interface	RS 232	RS 232	RS 232	
Dimensions (WxDxH), cm	35x39x54	35x39x54	35x39x54	
System weight, kg	25 (27)	26 (28)	27 (29)	
Operation weight, kg	28 (31)	29 (32)	30 (33)	

* Q-Front EDI electrodeionization module life is not limited as it is regenerated automatically

FLOW DIAGRAM

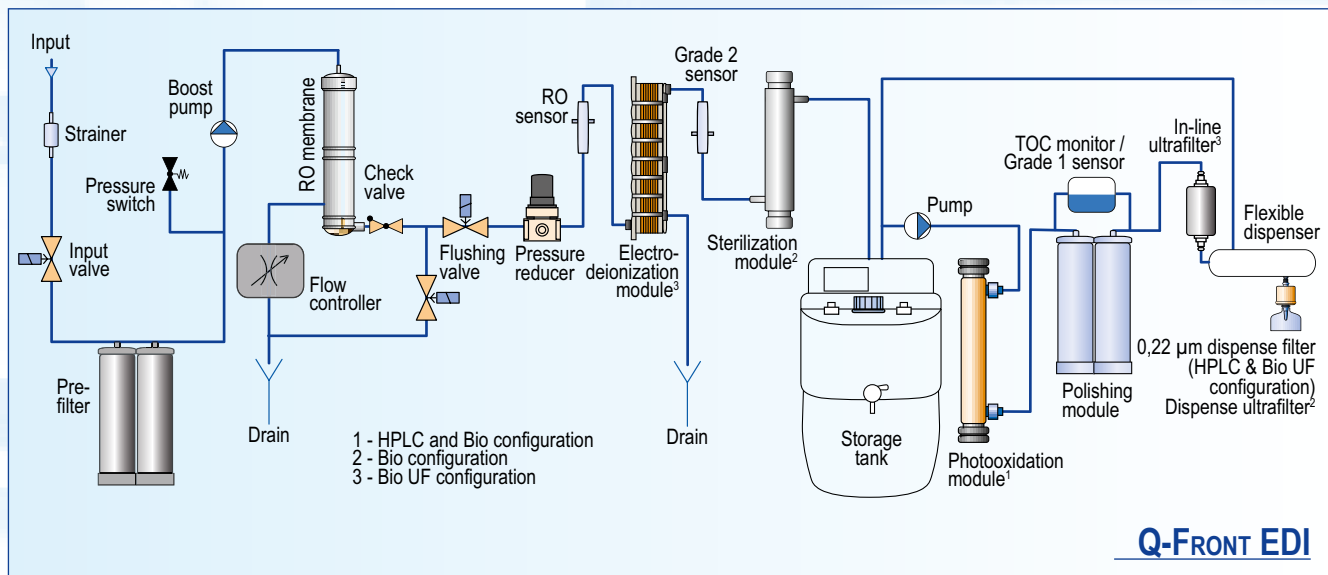

Q-FRONT EDI PURE

The compact and user-friendly Q-Front EDI Pure systems are highly recommended as the pure water source in your laboratory, providing Grade 2 water for a wide range of general laboratory applications.

The Q-Front EDI Pure systems purify the incoming feed water by electrodeionization technology, which is the most cost-effective long-term solution due to reduced running costs, as no deionization cartridges have to be replaced.



SPECIFICATIONS

	Q-Front EDI Pure
Grade 2 water resistivity at 25 °C	10.0 ... 5.0 MΩ x cm
Grade 2 water conductivity at 25 °C	0.1 ... 0.2 µS/cm
Particles >0.22 µm	<1/mL
TOC	<10 ppb
Nominal flow, pure water (to storage tank), depending on model	5 / 10 / 15 L/h
Deionization module life*	-
Data interface	RS 232
Dimensions (WxDxH), cm	35x39x54
System weight, kg	26
Operation weight, kg	29
Feed water pressure	0.4 - 6 bar

* Q-Front EDI electrodeionization module life is not limited as it is regenerated automatically

DESCRIPTION

	Q-Front EDI Pure
Water type	Pure
Display	colour graphic LCD display
Water quality sensor	•
TOC Monitor	-
Measurement validation port	-
Volumetric dispense	-
Dispenser	-
Connection to Flow point	-
In-line ultrafilter	-
Storage tank	required, not included
Installation	installable on a laboratory bench

FLOW DIAGRAM

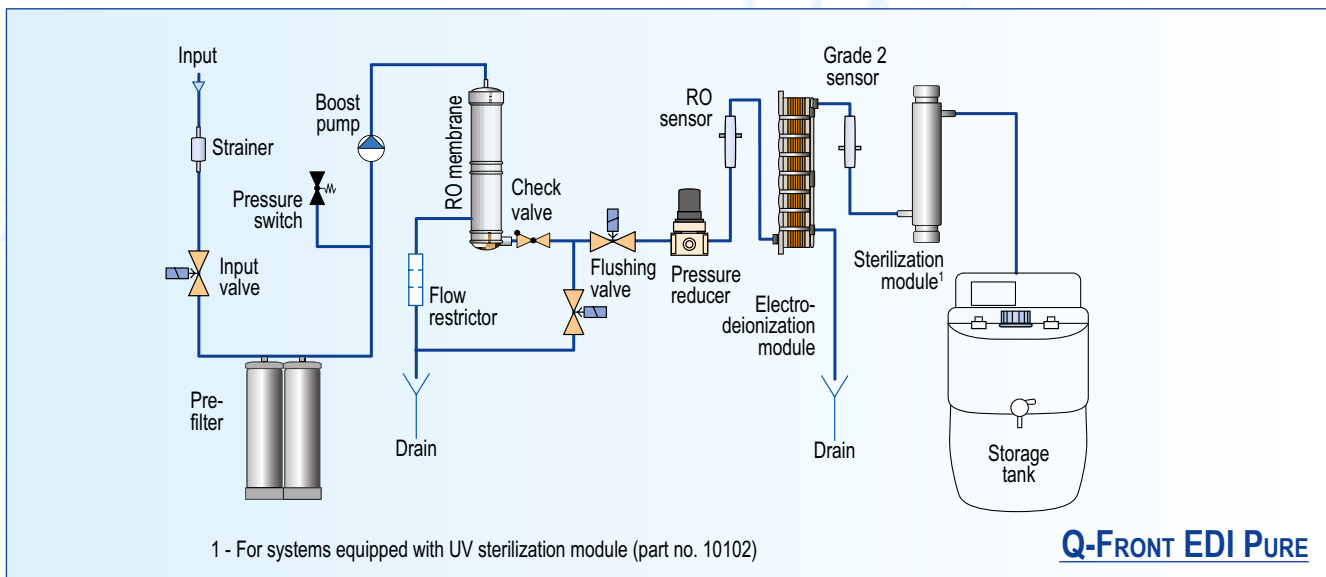

CONSUMABLES

Part number	Description	Replacement criteria	Comments
10310	Deionization module	When indicated on the display or water conductivity is constantly $> 0.5 \mu\text{S}/\text{cm}$ during tank filling stage	
10030	Polishing module "Polishing+"	When indicated on the display or water conductivity is constantly $> 0.1 \mu\text{S}/\text{cm}$ during recirculation	
10410	Pre-filter set	Filter life counter is zero or the filter is clogged	
10018	UV photooxidation bulb	2 years on average	Only for „Bio” and „HPLC”
10012	Point-of-use microfilter	Every 6–12 months	Only for „Trace” and „HPLC”
10120	Point-of-use ultrafilter	Every 3–6 months	Only for „Bio”
11200	In-line ultrafilter	Every 6–12 months	Only for “Bio UF”
10011	UV sterilization bulb	When required (on average every 2 years)	Only for „Bio”

INTEGRITY+



The high-end Integrity+ series water purification systems produce ultrapure and pure water for laboratory needs. Integrity+ series systems contain a 5 L embedded tank to keep the system compact.

DESCRIPTION

	Integrity+ Trace	Integrity+ HPLC	Integrity+ Bio	Integrity+ Bio UF
Water type	ultrapure water (Grade 1)	ultrapure water (Grade 1)	ultrapure water (Grade 1)	
Application	<ul style="list-style-type: none"> • atomic absorption spectrometry • plasma optical emission spectrometry • other inorganic trace analysis 	<ul style="list-style-type: none"> • chromatography • mass spectrometry • microbiology • molecular biology 	highly sensitive biology applications	
Display	colour graphic LCD display			
Conductivity sensor	•	•	•	•
TOC Monitor	-	•	•	•
Measurement validation port	•	•	•	•
Volumetric dispensing	•	•	•	•
Connection to Flow point*	•	•	•	•
In-line ultrafilter	-	-	-	•
Storage tank	integrated tank 5L			
Installation	installable either on a laboratory bench or on a wall			

* Dispenser-ready configuration required

ORDERING INFORMATION

Model	Part number
Integrity+ Trace	CB-2101
Integrity+ HPLC	CB-2103
Integrity+ Bio	CB-2105
Integrity+ Bio UF	CB-2115
Water quality sensor validation dongle	410913
IQ/OQ documentation	410141

SPECIFICATIONS

	Integrity+ system configuration			
	Trace	HPLC	Bio	Bio UF
Grade 1 water resistivity at 25 °C	18.2 MΩ x cm	18.2 MΩ x cm	18.2 MΩ x cm	
Grade 1 water conductivity at 25 °C	0.055 µS/cm	0.055 µS/cm	0.055 µS/cm	
Grade 2 water conductivity at 25 °C	0.1 µS/cm	0.1 µS/cm	0.1 µS/cm	
Total Organic Carbon (TOC) level	<10 ppb	<2 ppb	<2 ppb	
RNase	-	-	<0.01 ng/mL	
DNase	-	-	<4 pg/µL	
Bacteria	<0.01 CFU /mL	<0.01 CFU /mL	<0.01 CFU /mL	
Endotoxins	<0.15 EU /mL	<0.15 EU /mL	<0.001 EU /mL	
Particles >0.22 µm	<1/mL	<1/mL	<1/mL	
Deionization module life	1 m ³	1 m ³	1 m ³	
Dimensions (WxDxH), cm	32x56x62	32x56x62	32x56x62	
System weight, kg	24	25	26	
Operation weight, kg	27	28	29	
Data interface	RS 232	RS 232	RS 232	
Feed water pressure	2 – 6 bar	2 – 6 bar	2 – 6 bar	

CONSUMABLES

Part number	Description	Replacement criteria	Comments
10310	Deionization module	When indicated on the display or water conductivity is constantly $> 0.5 \mu\text{S}/\text{cm}$ during tank filling stage	
10030	Polishing module "Polishing+"	When indicated on the display or water conductivity is constantly $> 0.1 \mu\text{S}/\text{cm}$ during recirculation	
10319	Pre-filter set	Filter life counter is zero or the filter is clogged	
10018	UV photooxidation bulb	2 years on average	Only for „Bio” and „HPLC”
10012	Point-of-use microfilter	Every 6–12 months	Only for „Trace” and „HPLC”
10120	Point-of-use ultrafilter	Every 3–6 months	Only for „Bio”
11200	In-line ultrafilter	Every 6–12 months	Only for “Bio UF”
10017	Replacement Sterilization UV bulb	When required (on average every 2 years)	Only for „Bio”

FLOW DIAGRAMS

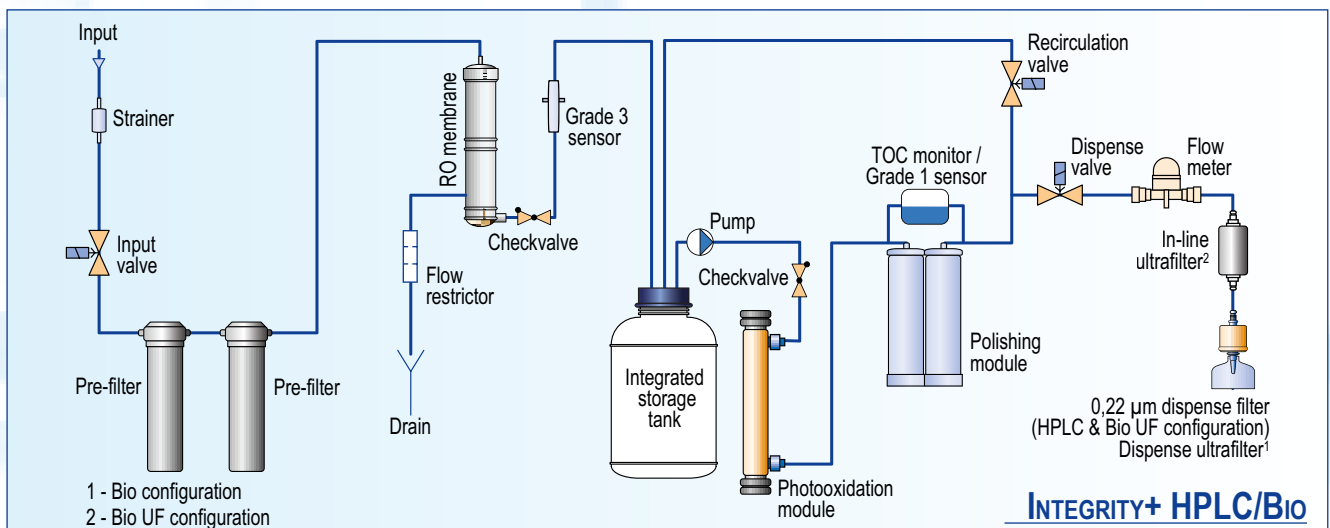
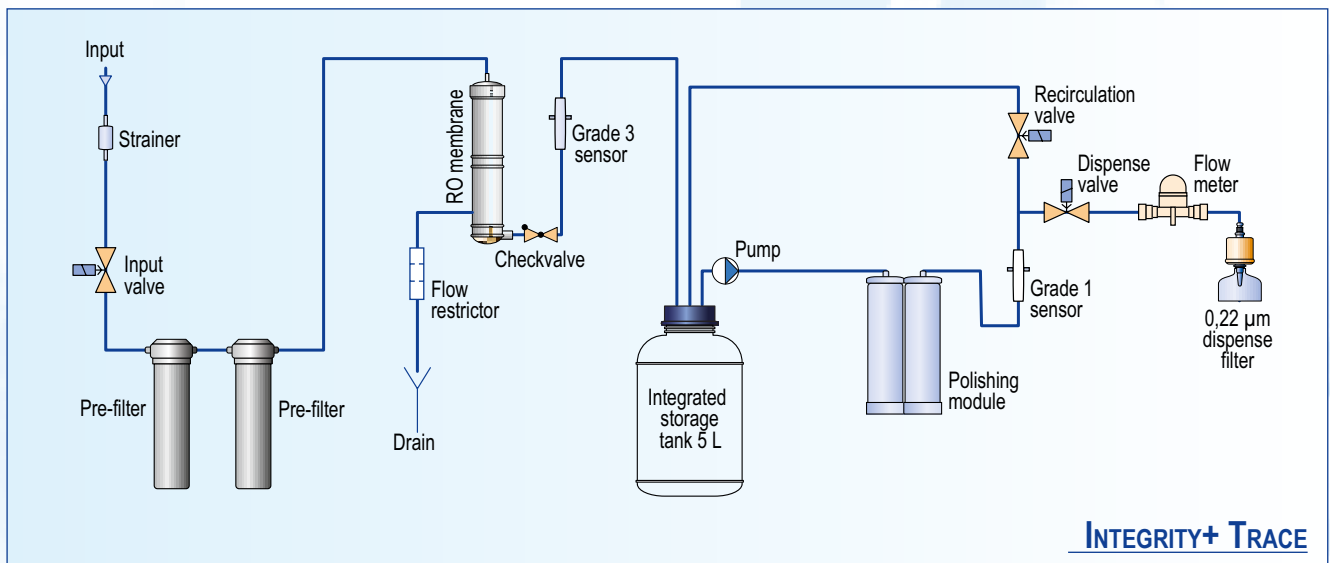

E30

E30 water purification system produce ultrapure and pure water for laboratory needs. It is designed for maximum convenience of use and to have maximum features. Is it a system with high price/performance ratio.

ORDERING INFORMATION

Model	Part number
E30 Trace	CE30-1001
E30 HPLC	CE30-1101
E30 Bio	CE30-1201
E30 Bio UF	CE30-1211



DESCRIPTION

	E30 Trace	E30 HPLC	E30 Bio	E30 Bio UF
Water type	<ul style="list-style-type: none"> ultrapure water (Grade 1) pure water (Grade 2) 	<ul style="list-style-type: none"> ultrapure water (Grade 1) pure water (Grade 2) 	<ul style="list-style-type: none"> ultrapure water (Grade 1) pure water (Grade 2) 	
Application	<ul style="list-style-type: none"> atomic absorption spectrometry plasma optical emission spectrometry other inorganic trace analysis 	<ul style="list-style-type: none"> chromatography mass spectrometry microbiology molecular biology 	highly sensitive biology applications	
Display	colour LCD display			
Conductivity sensor	•	•	•	•
TOC Monitor	-	•	•	•
Measurement validation port	-	-	-	-
Volumetric dispensing	•	•	•	•
In-line ultrafilter	-	-	-	•
Storage tank	required but not included			
Installation	installable on a laboratory bench			

SPECIFICATIONS

	E30 Trace	E30 HPLC	E30 Bio	E30 Bio UF
Grade 1 water resistivity at 25 °C	18.2 MΩ x cm	18.2 MΩ x cm	18.2 MΩ x cm	
Grade 1 water conductivity at 25 °C	0.055 μS/cm	0.055 μS/cm	0.055 μS/cm	
Grade 2 water conductivity at 25 °C	0.1 μS/cm	0.1 μS/cm	0.1 μS/cm	
Total Organic Carbon (TOC) level	<10 ppb	<2 ppb	<2 ppb	
RNase	N/A	N/A	<0.01 ng/mL	
DNase	N/A	N/A	<4 pg/μL	
Bacteria	<0.01 CFU/mL	<0.01 CFU/mL	<0.01 CFU/mL	
Endotoxins	<0.15 EU/mL	<0.15 EU/mL	<0.001 EU/mL	
Particles >0.22 μm	<1 per mL	<1 per mL	<1 per mL	
Nominal flow, pure water (to storage tank)	10 L/h	10 L/h	10 L/h	
Deionization module life (standard module)	1 m ³	1 m ³	1 m ³	
Recovery	>30 %	>30 %	>30 %	
Dimensions (WxDxH), cm	40x35x55	40x35x55	40x35x55	
System weight, kg	17	18	19	
Operation weight, kg	24	25	26	
Feed water pressure	0.4- 6 bar	0.4- 6 bar	0.4- 6 bar	
Feed water conductivity	< 1500 μS/cm	< 1500 μS/cm	< 1500 μS/cm	

CONSUMABLES

Part number	Description	Replacement criteria	Comments
10320	Replacement pre-filter, E30	Filter life counter is zero or the filter is clogged	
10310	Replacement deionization module	„Error 1” message is shown, or water conductivity is consistently > 0.5 µS/cm	
10030	Polishing module “Polishing+”	Every 1–2 years, depending on operation	
10017	Replacement sterilization UV bulb	When required (on average every 2 years)	„Bio” systems only
10018	Replacement photooxidation UV bulb	2 years on average	„HPLC” and „Bio” systems only
10012	Replacement 0.22 µm dispense microfilter	Every 6–12 months	„Trace” and „HPLC” systems
11200	In-line ultrafilter	Every 6–12 months	Only for „Bio UF”
10120	Replacement ultrafilter	Every 3–6 months	„Bio” systems only

FLOW DIAGRAMS

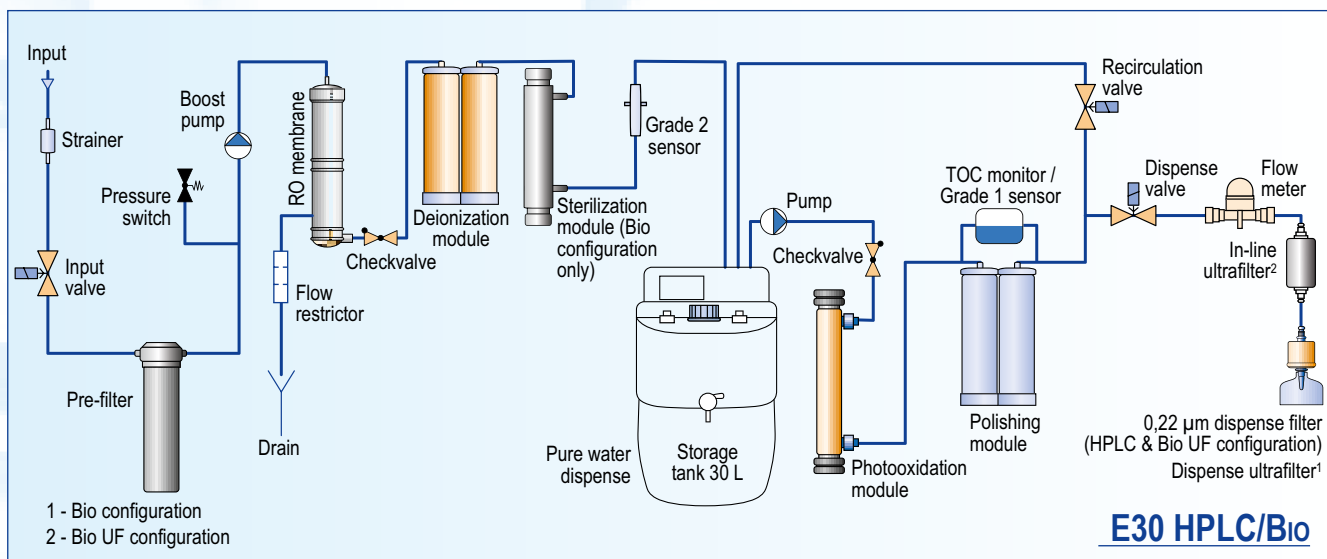
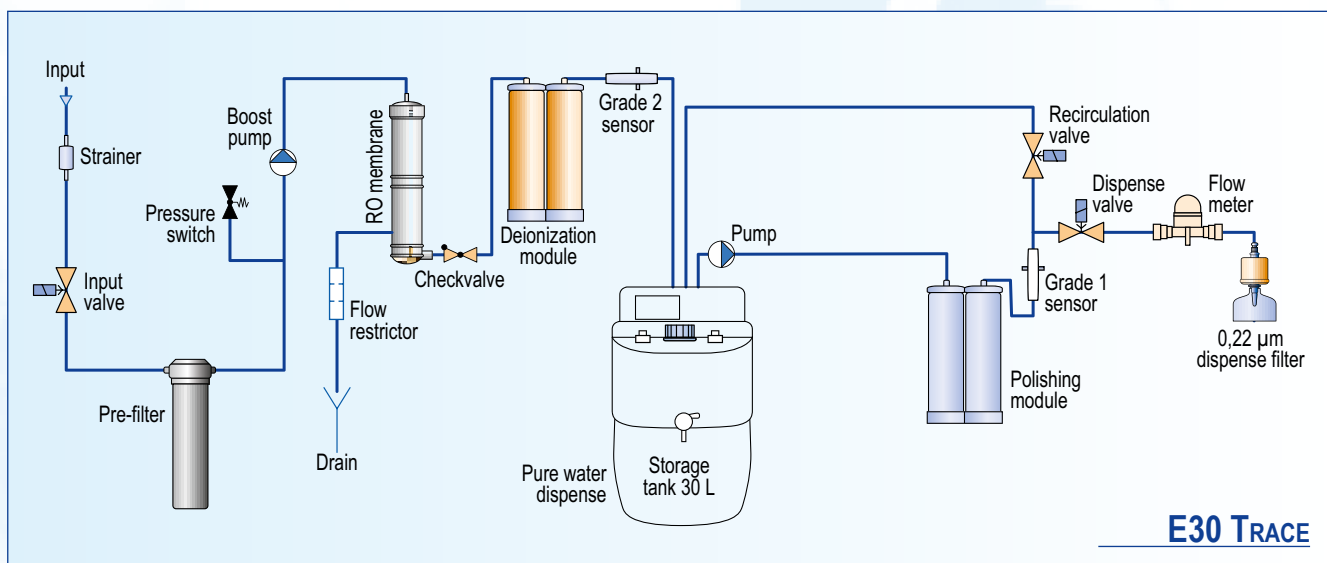

CRYSTAL EX

Adrona Crystal EX produces ultrapure and pure water. This multipurpose water purification system is highly appreciated due to the very affordable price.



ORDERING INFORMATION

Model	Part number
Crystal EX Trace	EX-1001
Crystal EX HPLC	EX-1101
Crystal EX Bio	EX-1201

DESCRIPTION EX SERIES

	Trace	HPLC	Bio
Water type	<ul style="list-style-type: none"> ultrapure water (Grade 1) pure water (Grade 2) 	<ul style="list-style-type: none"> ultrapure water (Grade 1) pure water (Grade 2) 	<ul style="list-style-type: none"> ultrapure water (Grade 1) pure water (Grade 2)
Application	<ul style="list-style-type: none"> atomic absorption spectrometry plasma optical emission spectrometry other inorganic trace analysis 	<ul style="list-style-type: none"> chromatography mass spectrometry microbiology molecular biology 	highly sensitive biology applications
Display	Monochrome LCD display		
Conductivity sensor	•	•	•
TOC Monitor	-	-	-
Measurement validation port	-	-	-
Volumetric dispensing	-	-	-
Connection to Flow point	-	-	-
Storage tank	required but not included		
Installation	installable on a laboratory bench		

SPECIFICATIONS

	Crystal EX Trace	Crystal EX HPLC	Crystal EX Bio
Grade 1 water resistivity at 25 °C	18.2 MΩ x cm	18.2 MΩ x cm	18.2 MΩ x cm
Grade 1 water conductivity at 25 °C	0.055 μS/cm	0.055 μS/cm	0.055 μS/cm
Grade 2 water resistivity at 25 °C	>10 MΩ x cm	>10 MΩ x cm	>10 MΩ x cm
Grade 2 water conductivity at 25 °C	<0.1 μS/cm	<0.1 μS/cm	<0.1 μS/cm
Total Organic Carbon (TOC) level	<10 ppb	<2 ppb	<2 ppb
RNase	N/A	N/A	<0.01 ng/mL
DNase	N/A	N/A	<4 pg/μL
Bacteria	<0.01 CFU/mL	<0.01 CFU/mL	<0.01 CFU/mL
Endotoxins	<0.15 EU/mL	<0.15 EU/mL	<0.001 EU/mL
Particles >0.22 μm	<1 per mL	<1 per mL	<1 per mL
Nominal flow, pure water (to storage tank)	10 L/h	10 L/h	10 L/h
Deionization module life (standard module)	1 m ³	1 m ³	1 m ³
Recovery	>30 %	>30 %	>30 %
Dimensions (WxDxH), cm	40x35x55	40x35x55	40x35x55
System weight, kg	17	18	19
Operation weight, kg	24	25	26
Feed water pressure	0.4 – 4 bar	0.4 – 4 bar	0.4 – 4 bar
Feed water conductivity	< 1500 μS/cm	< 1500 μS/cm	< 1500 μS/cm

CONSUMABLES

Part number	Description	Replacement criteria	Comments
10320	Replacement pre-filter, Crystal EX	Filter life counter is zero or the filter is clogged	
10310	Replacement deionization module	„DI Err” message is shown, or water conductivity is consistently > 0.5 μS/cm	
10030	Polishing module “Polishing+”	Every 1–2 years, depending on operation	
10017	Replacement sterilization UV bulb	When required (on average every 2 years)	„Bio” systems only
10018	Replacement photooxidation UV bulb	2 years on average	„HPLC” and „Bio” systems only
10012	Replacement 0.22 μm dispense microfilter	Every 6–12 months	„Trace” and „HPLC” systems
10120	Replacement ultrafilter	Every 3–6 months	„Bio” systems only

FLOW DIAGRAMS

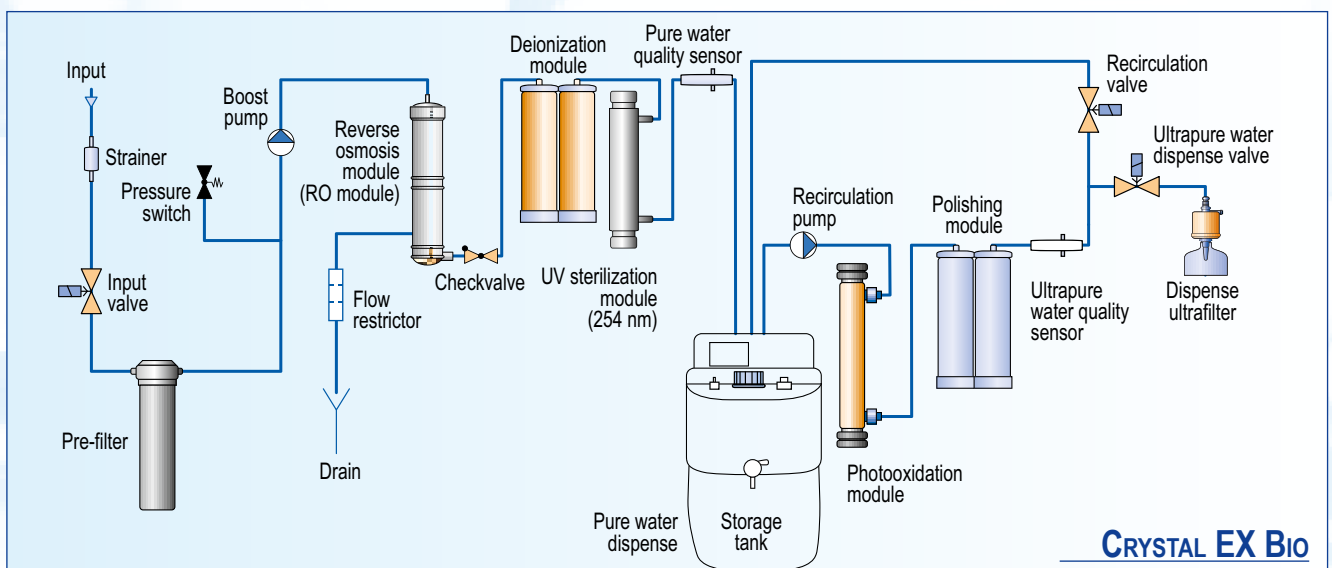
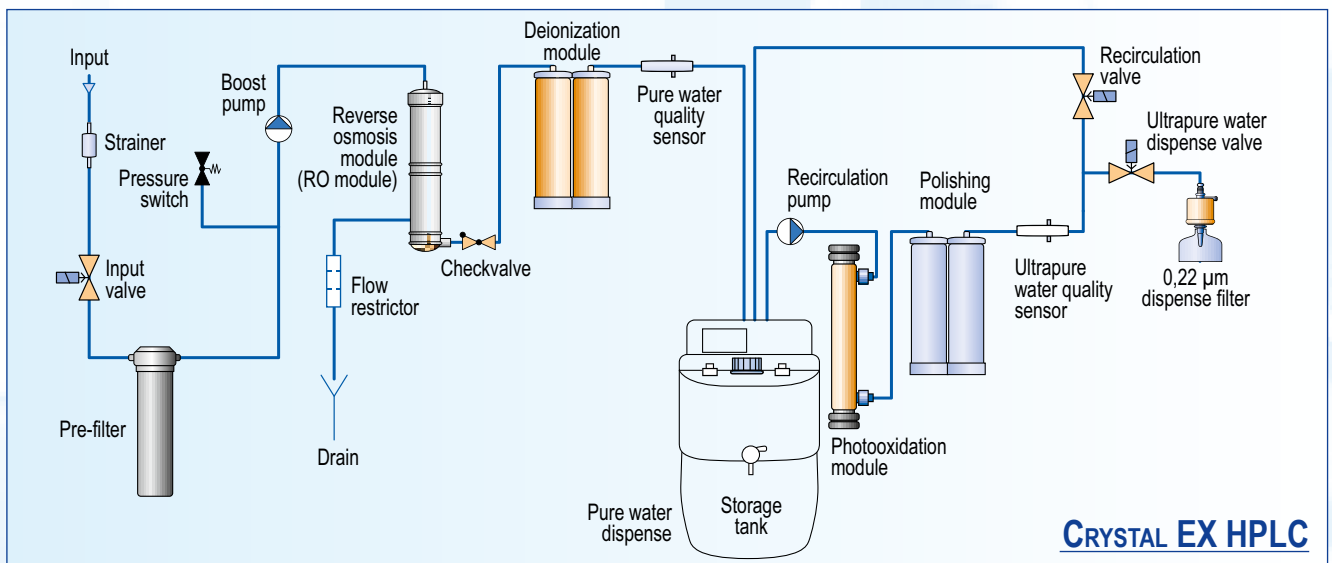
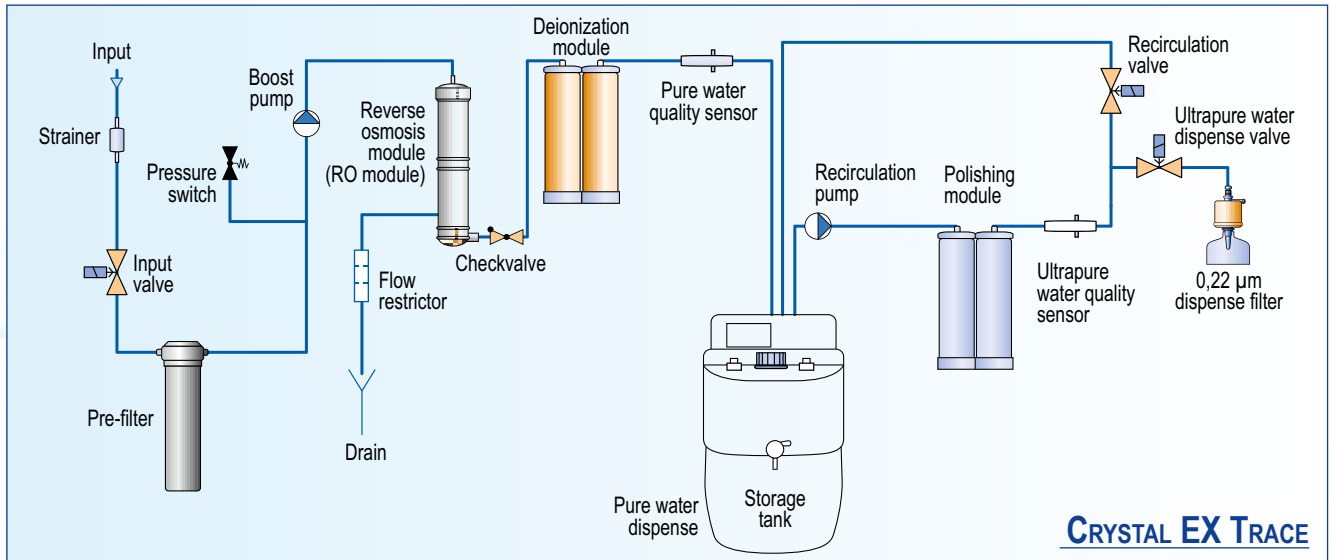



CRYSTAL EX PURE CRYSTAL EX DOUBLE FLOW CRYSTAL EX RO

Crystal EX RO and Pure systems produce pure (Grade 2) and RO (Grade 3) water. Pure and RO water comply with the requirements of a variety of applications, including:

- many inorganic methods of analysis (e. g. flame AAS);
- wet chemistry methods;
- electrochemistry;
- labware washing, etc.

The water purification system Crystal Double Flow is specially designed for the laboratories and applications with high water consumption (30 L/day and more). The system includes a high capacity (8L) deionization module, that provides a reduction of system running costs.

DESCRIPTION

	Crystal EX RO	Crystal EX Pure	Crystal EX Double Flow
Water type	RO water	pure water (Grade 2)	pure water (Grade 2)
Application	<ul style="list-style-type: none"> • wet chemistry methods • labware washing • steam sterilizers • polishers feed 	<ul style="list-style-type: none"> • flame spectrophotometry • inorganic analytical methods • electrochemistry • buffer preparation 	<ul style="list-style-type: none"> • flame spectrophotometry • inorganic analytical methods • electrochemistry • buffer preparation
Display	Monochrome LCD display		
Conductivity sensor	•	•	•
TOC Monitor	-	-	-
Measurement validation port	-	-	-
Volumetric dispensing	-	-	-
Connection to Flow Point	-	-	-
Storage tank	required but not included		
Installation	installable on a laboratory bench		

ORDERING INFORMATION

Model	Part number
Crystal EX RO	EX-1245
Crystal EX Pure	EX-1005
Crystal EX Double Flow	EX20-1002HC
Crystal EX Pure 4	EX-1004

SPECIFICATIONS

	Crystal EX RO	Crystal EX Pure	Crystal EX Double Flow
Purified water resistivity at 25 °C		>10 MΩ x cm	>10 MΩ x cm
Purified water conductivity at 25 °C	TDS rejection rate ≥97%	<0.1 µS/cm	<0.1 µS/cm
Particles >0.22 µm	<1 per mL	<1 per mL	<1 per mL
Nominal flow, pure water (to storage tank)	10 L/h	10 L/h	20 L/h
Deionization module life (standard module)	N/A	1 m ³	N/A
Deionization module life (high capacity module)	N/A	N/A	3 m ³
Recovery	>30 %	>30 %	>30 %
Dimensions (WxDxH), cm	40x35x55	40x35x55	40x50x55
System weight, kg	10	12	26
Operation weight, kg	13	16	39
Feed water pressure	0.4 – 4 bar	0.4 – 4 bar	0.4 – 4 bar
Feed water conductivity	< 1500 µS/cm	< 1500 µS/cm	< 1500 µS/cm

CONSUMABLES

Part number	Description	Replacement criteria	Comments
10320	Replacement pre-filter	Filter life counter is zero or the filter is clogged	“RO” and “Pure” systems only
10410	Replacement pre-filter set	Filter life counter is zero or the filter is clogged	“EX Double Flow” system only
10310	Replacement deionization module	„DI Err” message is shown, or water conductivity is consistently > 0.5 µS/cm	“Pure” systems only
10113	Replacement high-capacity deionization module	„DI Err” message is shown, or water conductivity is consistently > 0.5 µS/cm	“EX Double Flow” only
10017	Replacement sterilization UV bulb	As required (on average every 2 years)	Only systems with 10102 option

FLOW DIAGRAMS

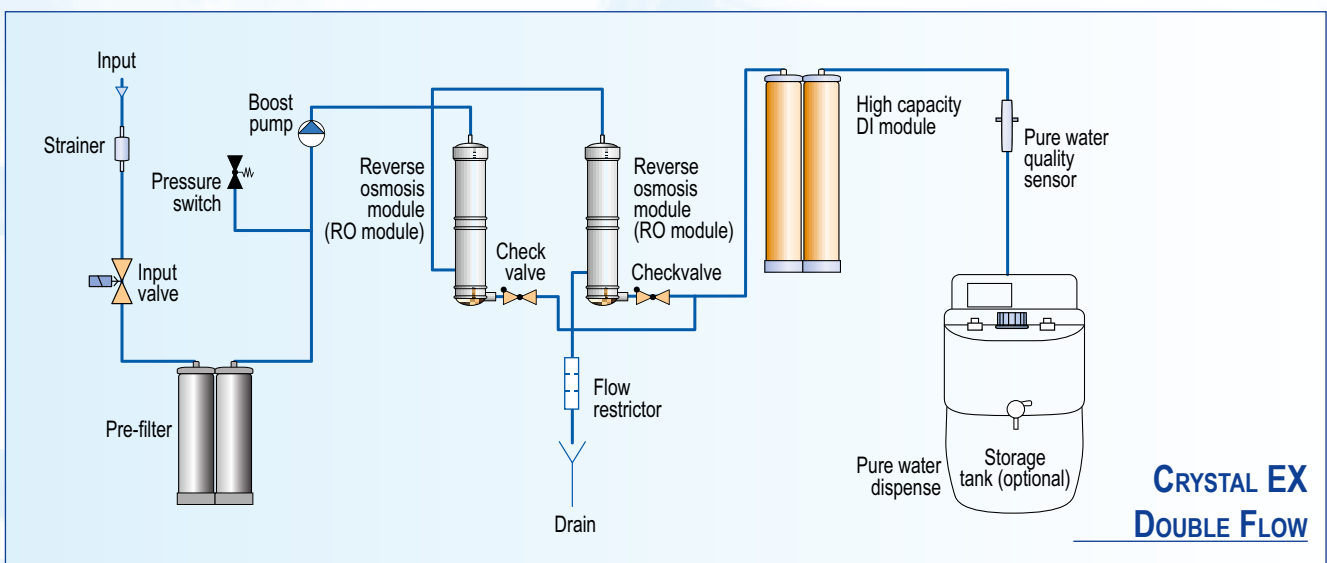
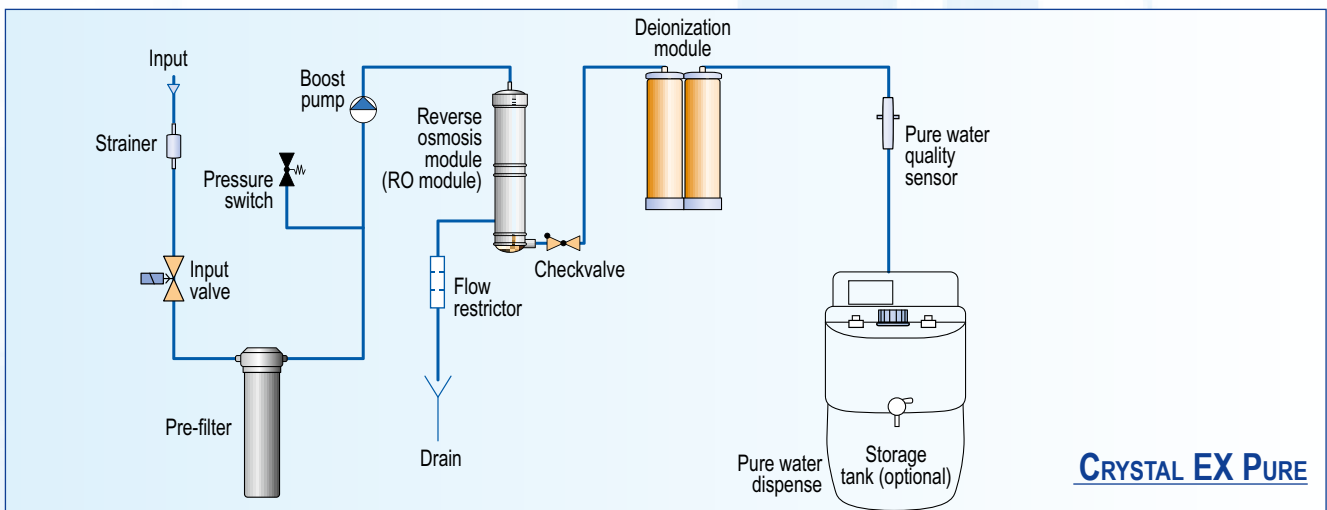
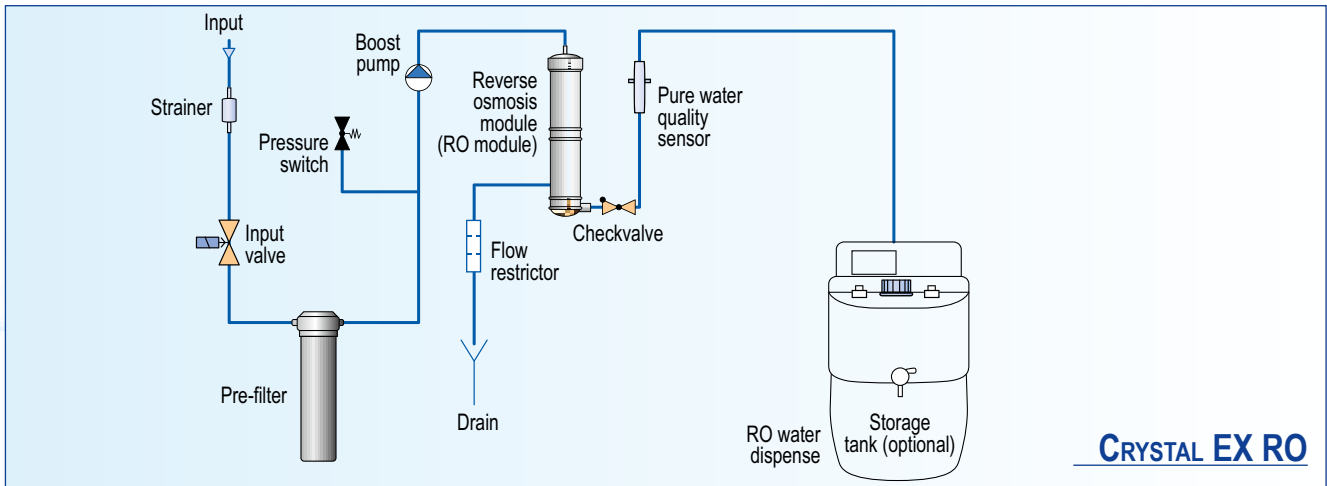

CRYSTAL CLINIC

The Crystal Clinic water purification system is designed to provide purified water for smooth and reliable operation of automated biochemistry analyzers.

Crystal Clinic has two reverse osmosis modules and high capacity deionization cartridge (DI). Large DI cartridge volume significantly reduces running costs.

Crystal Clinic has two water quality sensors. The first sensor controls quality of water in the storage tank. The second sensor controls quality of water supplied to a biochemical analyzer.



DESCRIPTION

Water type	Pure
Application	purified water for automated biochemistry analyzers
Display	monochrome LCD display
Conductivity sensor	•
TOC Monitor	-
Measurement validation port	-
Volumetric dispensing	-
Connection to Flow Point	-
Pressurized storage tank	required, not included
Installation	installable on a laboratory bench

ORDERING INFORMATION

Model	Part number
Crystal Clinic	CL-2910

SPECIFICATIONS

	Crystal Clinic
Grade 2 water resistivity at 25 °C	>10 MΩ x cm
Grade 2 water conductivity at 25 °C	<0.1 μS/cm
Particles >0.22 μm	<1 per mL
Nominal flow, pure water (to storage tank)	20 L/h
Dispense flow to analyzer	4 L/min
Dispense pressure (adjustable)	100 - 180 kPa
Deionization module life (high capacity module)	3 m ³
Recovery	>30 %
Dimensions (WxDxH), cm	40x50x55
System weight, kg	26
Operation weight, kg	39
Pressurized storage tank*	100 L
Feed water pressure	0.4 – 4 bar
Feed water conductivity	< 1500 μS/cm

* Required but not included. Other capacities available.

CONSUMABLES

Part number	Description	Replacement criteria	Comments
10410	Replacement pre-filter	Filter life counter is zero or the filter is clogged	
10113	Replacement high-capacity deionization module	„DI Err” message is shown, or water conductivity is consistently > 0.5 $\mu\text{S}/\text{cm}$	
10017	Replacement sterilization UV bulb	When required (on average every 2 years)	
10012	Replacement 0.22 μm dispense microfilter	Every 6–12 months	

FLOW DIAGRAM

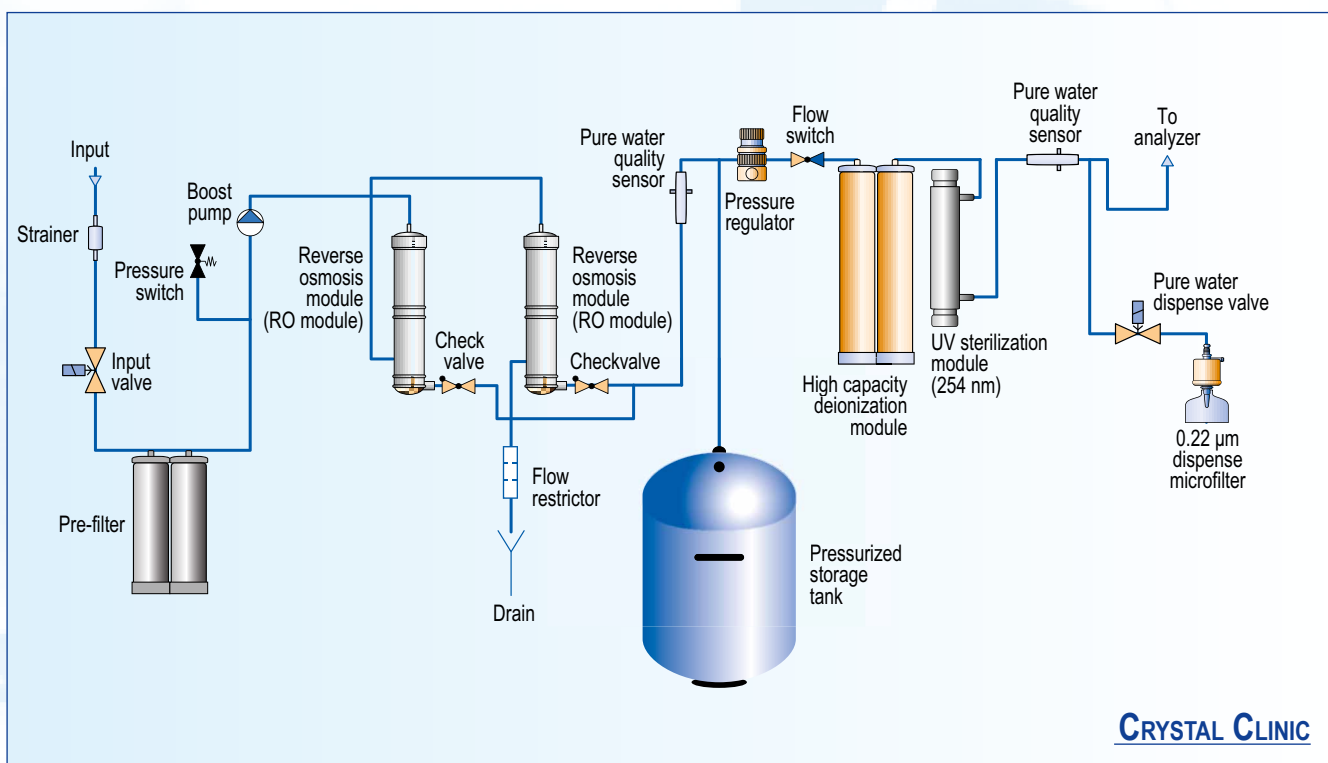

CRYSTAL STERIFEED



Sterifeed is a water purification system that is specially designed to produce feed water for autoclaves and laboratory washing machines.

Pressurized water storage tank provides consistent water supply to an autoclave. Many autoclaves need pressurized purified water supply. Some autoclaves have priming pumps for purified water

intake, but in case the water supply is not pressurized, an air gap may block the water flow. If the blockage occurs, the operation of autoclave is not possible until the air is removed from the system. Pressurized water storage tank of the “Sterifeed” system eliminates any possibility of air gap formation and ensures smooth operation of an autoclave.

DESCRIPTION

Water type	RO water (Grade 3)
Application	purified water for autoclaves
Display	monochrome LCD display
Conductivity sensor	•
TOC Monitor	-
Measurement validation port	-
Volumetric dispensing	-
Connection to Flow Point	-
Pressurized storage tank	required, not included
Installation	installable on a wall

ORDERING INFORMATION

Model	Part number
Crystal Sterifeed	CS-1002

SPECIFICATIONS

	Sterifeed
TDS rejection rate	≥97%
Particles >0.22 µm	<1 per mL
Nominal flow, pure water (to storage tank)	10 L/h
Deionization module life	N/A
Recovery	>30 %
Dimensions (WxDxH), cm	55x21x50
System weight, kg	11
Operation weight, kg	16
Pressurized storage tank*	60 L
Feed water pressure	0.4 – 4 bar
Feed water conductivity	<1500 µS/cm

* Required but not included. Other capacities available.

CONSUMABLES

Part number	Description	Replacement criteria	Comments
10016	Replacement pre-filter set, Sterifeed	Filter life counter is zero or the filter is clogged	

FLOW DIAGRAM

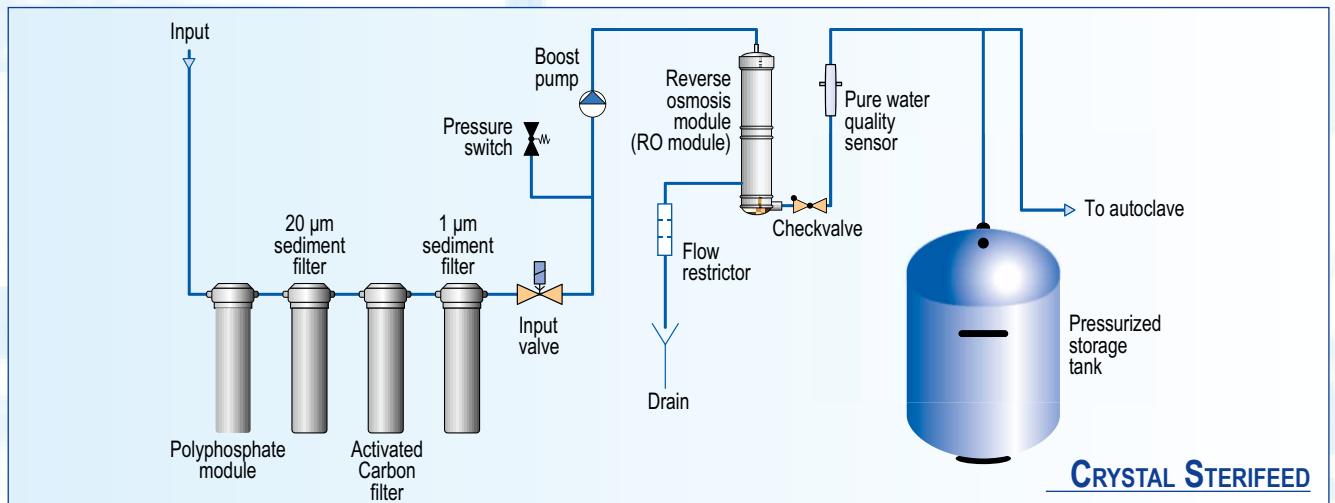



CONNECT LT

The new version of market approved laboratory water polishing system - Connect received totally new electronics and software. As a result there are number of the new features - full colour touch screen, USB and Ethernet connections and available history of dispense reports.

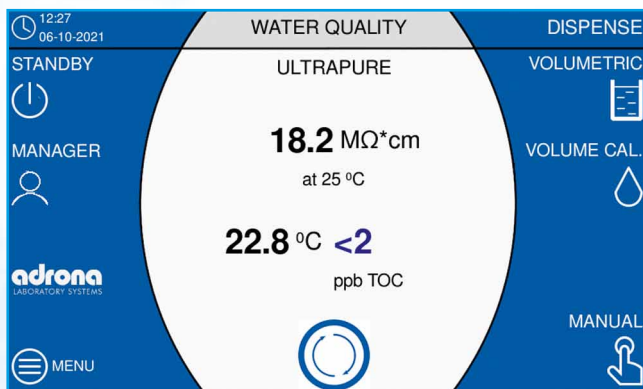

COMPACT

- Total dimensions: 330 mm wide, 630 mm high
- Integral to your bench work

LARGE TOUCHSCREEN

- Simplified and detailed information in multiple languages
- Alerts and alarms are visible on the main screen with complete information on actions required
- Monitoring the operation of the system.

EASY TO USE

- Water delivered up to 2 liters a minute keeps interruptions to a minimum
- Volumetric dispensing allows fast reissue of volumes
- Volumetric control is available from 20 ml to 20 liters

CONVINIENT

- Easy menu navigation in multiple languages
- Easy access to change consumables

COST EFFECTIVE

- All consumables included
- Large volume DI cartridge
- Space saving design means a more efficient laboratory and team

ONSITE+ AND CONNECT SERIES

Onsite+ and Connect are hi-end polishing water purification systems. The feed water must be pre-treated by reverse osmosis or distillation. Systems are recommended for laboratories with average daily consumption of water within 5-10 litres.

Onsite+ series systems contain an embedded tank that has to be filled with pre-treated water before operation. Pre-treated water can be obtained by distillation or reverse osmosis. For user convenience the Onsite+ system comes with additional 5L carboy. The carboy has a stopcock and handle for easy transportation of water from water still to the Onsite+ unit.

Connect series systems should be connected to a water pre-treatment unit or a distilled water distribution system in a lab. The pre-treatment system should maintain water pressure of no less than 1 bar.



ORDERING INFORMATION

Model	Part number
Onsite+ Trace	CB-1901
Onsite+ HPLC	CB-1903
Onsite+ Bio	CB-1905
Onsite+ Bio UF	CB-1915
Connect Trace	CB-1701
Connect HPLC	CB-1703
Connect Bio	CB-1705
Connect Bio UF	CB-1715
Water quality sensor validation kit	410913

DESCRIPTION ONSITE+ SERIES

	Trace	HPLC	Bio	Bio UF
Water type	ultrapure water (Grade 1)	ultrapure water (Grade 1)	ultrapure water (Grade 1)	
Application	<ul style="list-style-type: none"> atomic absorption spectrometry plasma optical emission spectrometry other inorganic trace analysis 	<ul style="list-style-type: none"> chromatography mass spectrometry microbiology molecular biology 	highly sensitive biology applications	
Display	colour graphic LCD display			
Conductivity sensor	•	•	•	•
TOC Monitor	-	•	•	•
Measurement validation port	•	•	•	•
Volumetric dispensing	•	•	•	•
Connection to Flow point*	•	•	•	•
In-line ultrafilter	-	-	-	•
Storage tank	integrated tank 5 L			
Installation	installable either on a laboratory bench or on a wall			

* Dispenser-ready configuration required

DESCRIPTION CONNECT SERIES

	Trace	HPLC	Bio	Bio UF
Water type	ultrapure water (Grade 1)	ultrapure water (Grade 1)	ultrapure water (Grade 1)	
Application	<ul style="list-style-type: none"> • atomic absorption spectrometry • plasma optical emission spectrometry • other inorganic trace analysis 	<ul style="list-style-type: none"> • chromatography • mass spectrometry • microbiology • molecular biology 	highly sensitive biology applications	
Display	colour graphic LCD display			
Conductivity sensor	•	•	•	•
TOC Monitor	option	•	•	•
Measurement validation port	•	•	•	•
Volumetric dispensing	•	•	•	•
Connection to Flow point*	•	•	•	•
In-line ultrafilter	-	-	-	•
Storage tank	Not included			
Installation	installable either on a laboratory bench or on a wall			

* Dispenser-ready configuration required

SPECIFICATIONS

	Onsite+/Connect system configuration			
	Trace	HPLC	Bio	Bio UF
Ultrapure water resistivity at 25 °C	18.2 MΩ x cm	18.2 MΩ x cm	18.2 MΩ x cm	
Ultrapure water conductivity at 25 °C	0.055 µS/cm	0.055 µS/cm	0.055 µS/cm	
Total Organic Carbon (TOC) level	<10 ppb	<2 ppb	<2 ppb	
RNase	-	-	<0.01 ng/mL	
DNase	-	-	<4 pg/µL	
Bacteria	<0.01 CFU/mL	<0.01 CFU/mL	<0.01 CFU/mL	
Endotoxins	<0.15 EU/mL	<0.15 EU/mL	<0.001 EU/mL	
Particles >0.22 µm	<1/mL	<1/mL	<1/mL	
Polishing module life*	1 m ³	1 m ³	1 m ³	
Dimensions (WxDxH), cm	30x44x64	30x44x64	30x44x64	
System weight, kg	16	17	17	
Operation weight, kg	21	22	22	
Feed water conductivity	< 100 µS/cm	< 100 µS/cm	< 100 µS/cm	

* Polishing module life depends on feed water quality.

CONSUMABLES

Part number	Description	Replacement criteria	Comments
10030	Polishing module "Polishing+"	When indicated on the display or water conductivity is constantly > 0.1 µS/cm during recirculation	
10018	UV photooxidation bulb	2 years on average	Only for „Bio” and „HPLC”
10012	Point-of-use microfilter	Every 6–12 months	Only for „Trace” and „HPLC”
10120	Point-of-use ultrafilter	Every 3–6 months	Only for „Bio”
11200	In-line ultrafilter	Every 6–12 months	Only for “Bio UF”

FLOW DIAGRAM

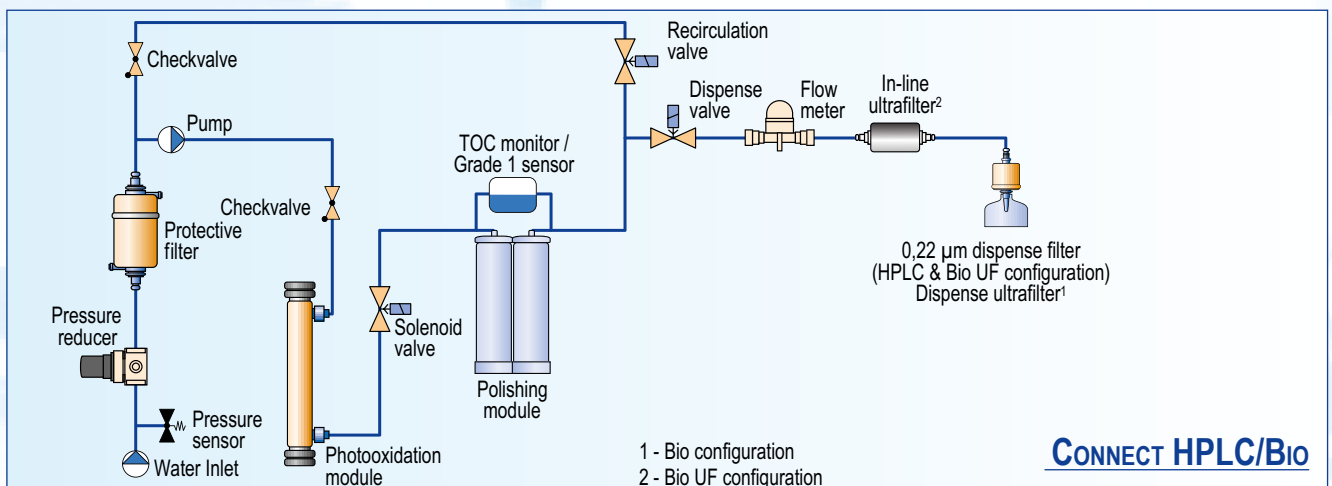
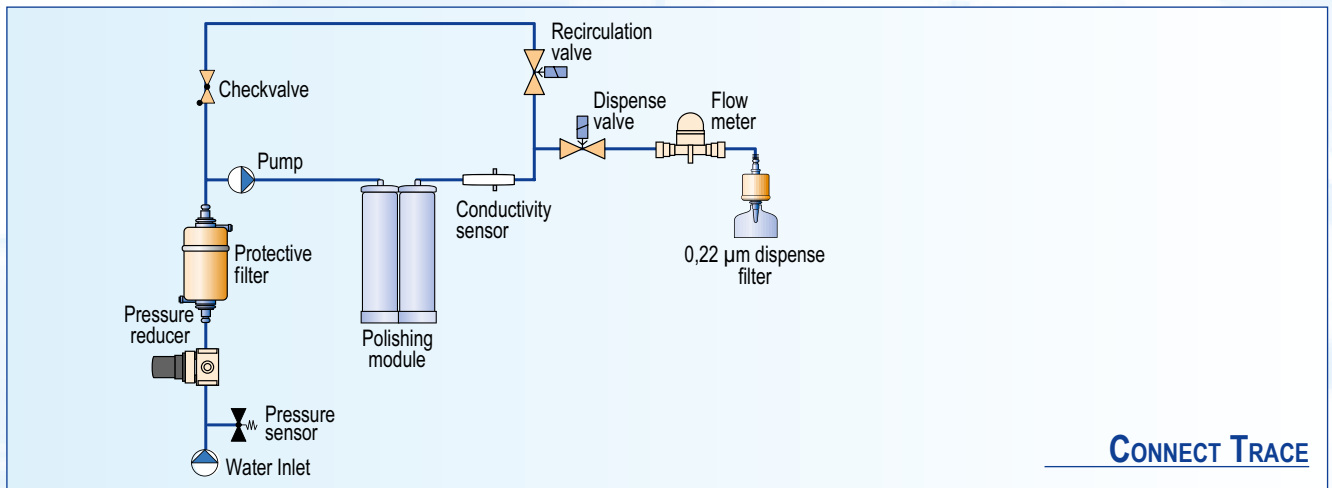
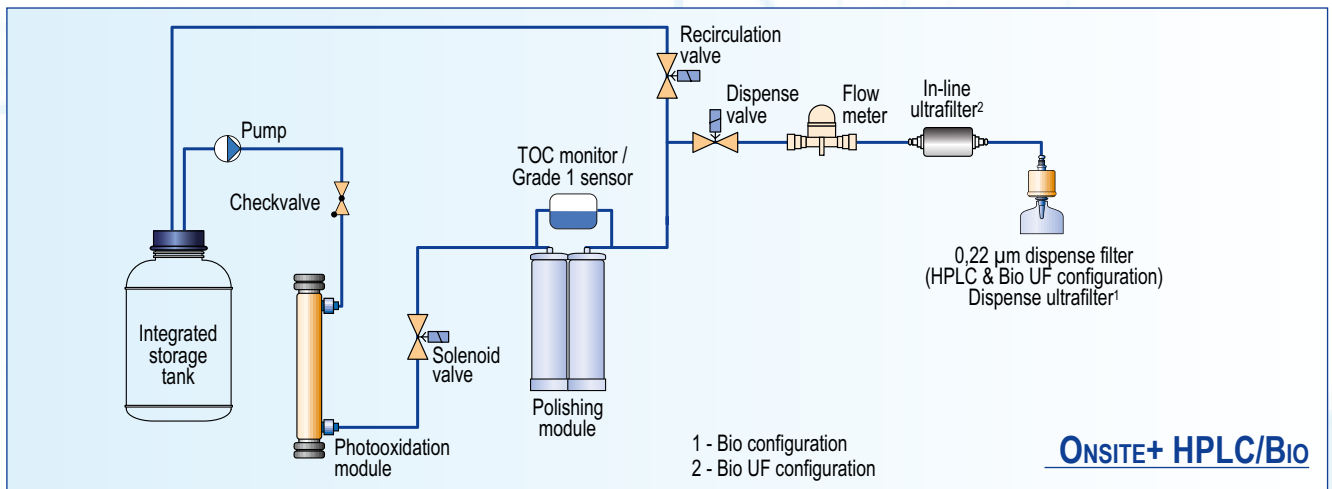
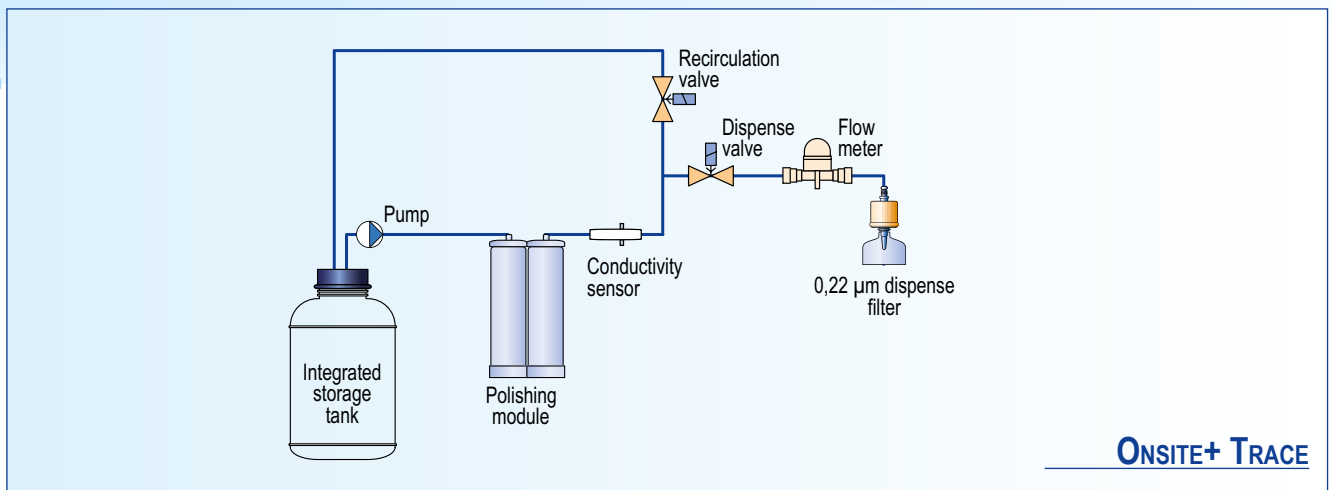



RADIX

When larger quantities of Grade 2 or RO water are required, our RADIX systems serve as a multi-purpose solution for a wide range of applications. Systems are available in RO or EDI configurations and, depending on the model, produce up to 100 L of RO water or 90 L of Grade 2 water per hour.

RADIX systems are designed as robust and reliable high-capacity purified water sources that require minimal maintenance while delivering exceptional output. The EDI configuration includes an electrodeionization module which needs no replacement and thus the long-term running costs are kept as low as possible.

Typical fields of application include but are not limited to:

- Central laboratory water distribution system which can supply purified water to the entire facility with a number of point-of-use access points and additional Grade 1 polishers installed according to the specific requirements.
- Feed water production to biochemical analyzers in hospitals, laboratories, healthcare centers (RADIX EDI – Grade 2 systems). Depending on water consumption, RADIX systems can simultaneously supply more than one analyzer. A typical setup includes the RADIX system, an atmospheric storage tank (equipped with an automatic UV sanitization module and CO₂ trap) and a water distribution module.
- Production facilities of different types of manufacturing industries.
- Supply of large capacity humidifiers, steam generators etc.

DESCRIPTION

	60 RO	100 RO	30 EDI	60 EDI	90 EDI	31 EDI	61 EDI	91 EDI
Ordering information	RA-1001	RA-1003	RA-2101	RA-2103	RA-2105	RA-2102	RA-2104	RA-2106
Capacity, L/h	60	100	30	60	90	30	60	90
TDS rejection rate	≥98.5%	≥98.5%	-	-	-	-	-	-
Output water conductivity at 25 °C, µS/cm	-	-	0.2	0.2	0.2	0.5	0.5	0.5
Feed water with elevated CO₂ level	-	-	-	-	-	•	•	•
Display	controller with colour display							
Dimensions (WxDxH), cm	33x65x72							
System weight, kg	42	56	50	56	60	50	56	60
Operation weight, kg	52	63	55	63	66	55	63	66

FLOW DIAGRAM

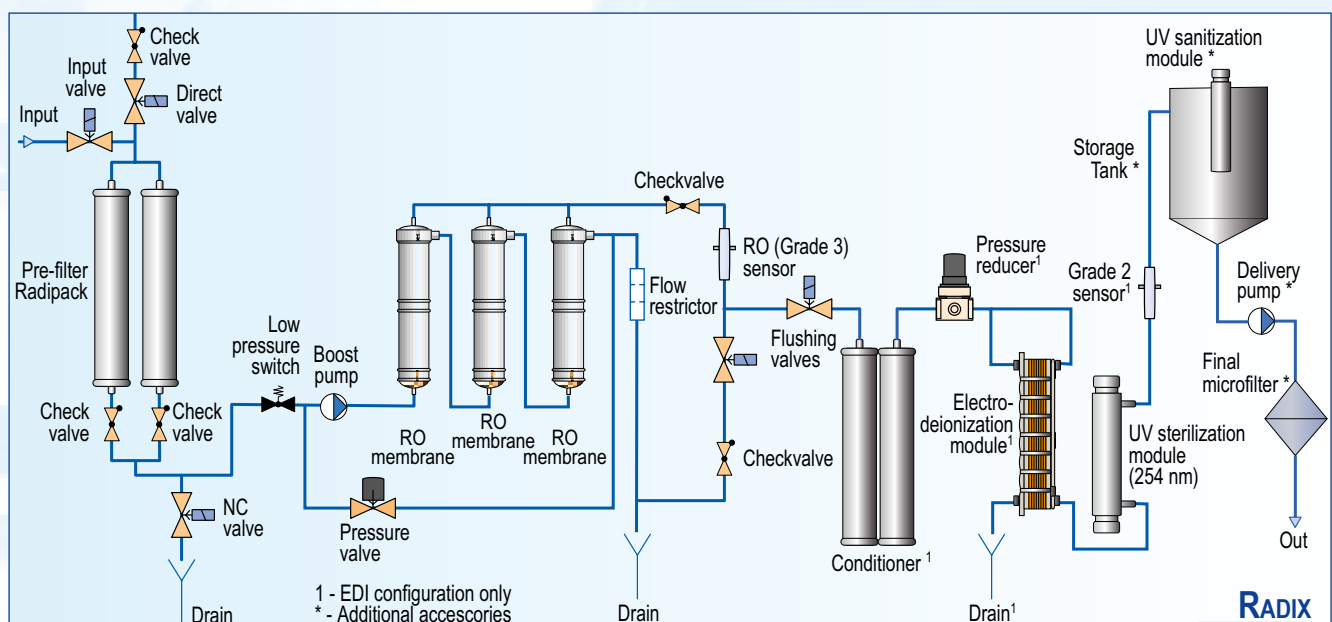

ACCESSORIES

For increased convenience of use of the Adrona water purification systems, choose from the variety of accessories to meet your specific needs.

STORAGE TANKS

Adrona water purification systems can be equipped with water storage tanks of various capacity. Depending on the consumption of purified water, user can choose the tank starting from tank with capacity of 10 litres up to 300 litres. All the storage tanks are equipped with level switch.

WATER STORAGE TANK “PRO”



Specially designed for significant reduction of microbiological contamination possibilities

Features:

- Capacity 30 litres
- Opaque housing walls for protection against light
- Conical bottom for complete draining
- Ergonomical design
- Equipped with stopcock
- Recirculation system for maintaining the water quality
- Automatic UV sanitization (UV lamp) module (option)
- Multi-position level switch, that enables precise control of remaining water
- Fast pure water dispense pump (option)
- Dimensions (WxDxH): 39x44x60 cm
- Weight: 6.5 kg

WATER DISPENSING UNIT “FLOW POINT 4”



Water dispensing unit provides more convenient use of Adrona systems.

- Adjustable in all dimensions
- Manual and/or volumetric dispensing with teaching mode
- Colour graphic LCD display
- Full remote control for water purification system
- Compatible with Gradus, Q-Front, Onsite+, Integrity+ and Connect systems

ORDERING INFORMATION

Model	Part number
Grade1 water dispenser	10426
Water storage tank “Pro” w/multi- position level switch, 30 L	11015
Water storage tank “Comfort” w/ level switch, w/ base, 60 L	10007
Water storage tank “Tiny” w/ level switch, dispense tap, 10L	11014
Storage tank “Comfort” w/ dispense pump, w/ base, 100L	10027
Storage tank “Comfort” w/ dispense pump, w/ base, 200L	10026
Storage tank “Comfort” w/ dispense pump, w/ base, 300L	10025
Automatic sanitization module for tank	10315
Water dispensing unit	10326
Universal remote dispenser	13009
UV sterilization module	10102

WATER STORAGE TANK
“COMFORT” 60 L



LABORATORY WATER SYSTEM SERVICE ACCESSORIES

Part number	Model	Specification
2CA100	Conductometer WTW cond 3110	0.00-20.00 M Ω x cm 0.001-200 μ S/cm
301961	Utrapure water conductivity cell	
91220	Hardness test strips	
HI98308	Conductivity tester PWT	0.00-99.9 μ S/cm
HI98304	Conductivity tester DIST4	0.00-20 mS/cm



ISO 9001

BUREAU VERITAS
Certification



adrona

Kalnciema str. 209, Rīga
LATVIA, LV – 1046
Tel.: +371 67551894, +371 67551993
Fax: +371 67551976
e-mail: info@adrona.lv
www.adrona.lv